

# Krippenelement „Burg“

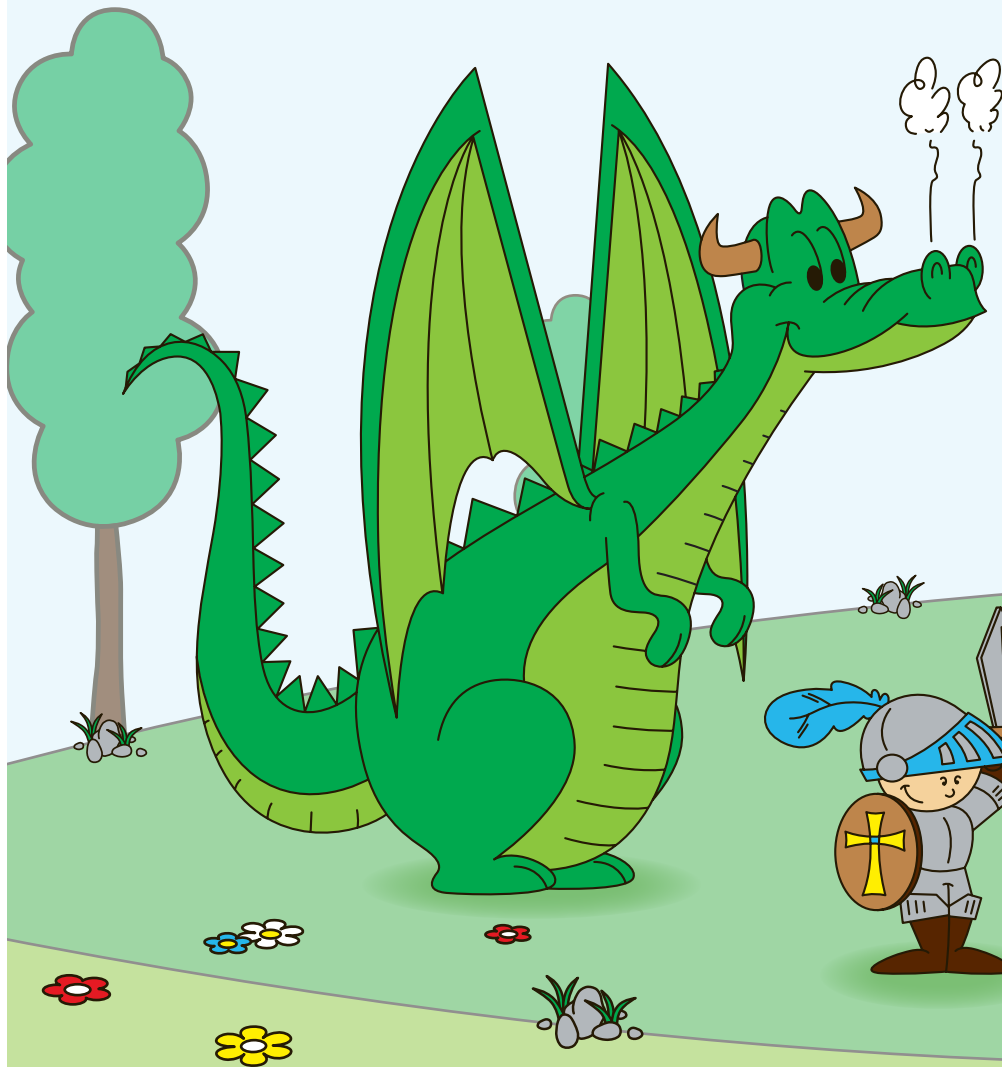

Lasst uns das Burgleben spielerisch entdecken ...

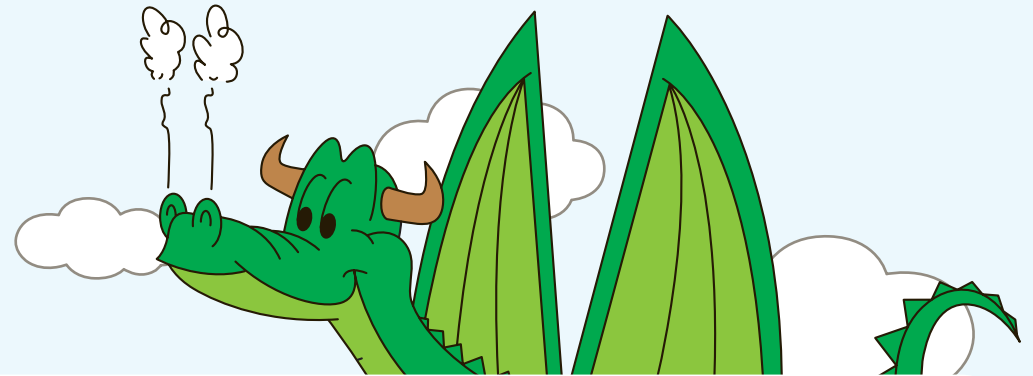

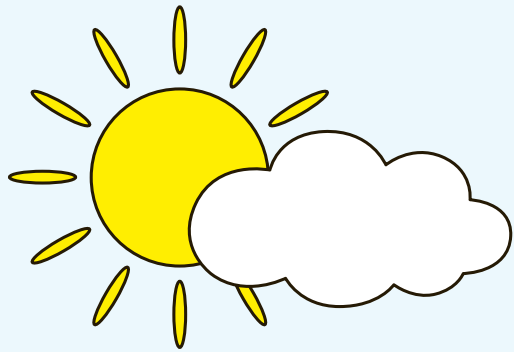

## Krippenelement „Burg“

Mit unseren 6 neuen „Burg“-Elementen können bereits die Kleinsten das „Burgleben“ spielerisch entdecken. Jedes Element bietet eine Vielzahl unterschiedlichster Funktionen, die durch ihre attraktive Gestaltung einen hohen Aufforderungscharakter für Kinder haben. Ob als Rondell (alle 6 Elemente zusammen) oder als Dreierkombination gestellt, je nach Platzbedarf bieten wir 3 verschiedene Aufbaumöglichkeiten an. Auch eine Befestigung an der Wand ist mit einem Zusatzset möglich. Das Krippenelement „Burg“ eignet sich optimal für den Einsatz in Kindereinrichtungen und Aufenthalts- und Gruppenräumen. Die Elemente wurden unter Beachtung der frühkindlichen Entwicklung konzipiert und vereinen Spielspaß und edukative Weiterentwicklung. Hier gibt es eine Menge zu entdecken. Den Kindern werden dabei in ihren Fantasien keine Grenzen gesetzt. Ob sie sich auf Verfolgungsjagd nach kleinen Schlossgeistern begeben oder für musikalische Unterhaltung auf der Burg sorgen, hier können Sie sich frei entfalten.

Alle Teile müssen sachgerecht fixiert und regelmäßig kontrolliert werden. Andernfalls können sie sich lösen oder sonstige Gefahren darstellen. • beleduc Lernspielwaren GmbH • [www.beleduc.de](http://www.beleduc.de)

**Alter:** 12M+

**Spieler:** 1+

**Größe:** 1177 x 700 x 12 mm (Tür), 700 x 600 x 12 mm (alle weiteren Elemente)

Die einzelnen Elemente sind für eine Montage durch einen Erwachsenen vorgesehen.



## Nursery Element „Castle“

With our 6 new „Castle“ elements, even the very young can discover „life in the castle“ while at play. Each element offers many different functions which are attractively designed to foster the development of children's skills. Whether arranged in a circle (all 6 elements together) or as a combination of three, we offer 3 different construction possibilities according to the space available. It is also possible to fix elements to the wall using an extra set. The Nursery Element „Castle“ is ideally suited for use in children's care premises, recreation rooms and group rooms. The elements have been designed bearing early childhood development in mind. They combine fun at play with educative further development. There is lots to discover in this series. No limits are set to the children's fantasy. Whether pursuing the castle's little ghosts or making music to entertain the castle residents, their imagination is given free rein.

All parts must be properly fixed and regularly controlled. Otherwise they may work loose, become detached or present a danger in other ways. • beleduc Lernspielwaren GmbH • [www.beleduc.de](http://www.beleduc.de)

**Age:** 12 months+

**Players:** 1+

**Size:** 1177 x 700 x 12 mm (door), 700 x 600 x 12 mm (all other elements)

The individual elements are intended to be assembled by adults.



## Élément mural pour crèche „Château fort“

Avec nos 6 nouveaux éléments « Château fort », nos tout petits peuvent déjà découvrir de manière ludique la « vie de château ». Chaque élément offre une multitude de fonctions différentes qui, en raison de leur conception séduisante, présente un caractère d'attractivité élevé pour les enfants. Que ce soit sous forme de rondelle (les 6 éléments ensemble) ou montés en triple combinaison, nous proposons, selon l'espace disponible 3 possibilités différentes de montage. Une fixation au mur est également possible, par l'intermédiaire d'un kit supplémentaire. L'élément pour crèche « Château fort » convient parfaitement pour l'utilisation dans les structures accueillant des enfants, dans des salles ou des classes. Les éléments ont été conçus dans le respect du développement des tout petits et combinent le plaisir du jeu avec une motivation éducative. Ils permettent de découvrir une foule de choses. L'imagination des enfants n'est toutefois pas bridée. Qu'ils se lancent à la poursuite de petits fantômes ou qu'ils créent un spectacle musical entre les murs du château, ils peuvent déployer ici librement tous leurs talents.

Tous les éléments doivent être fixés dans les règles de l'art et régulièrement contrôlés. Dans le cas contraire, ils pourraient se détacher ou représenter un danger. • beleduc Lernspielwaren GmbH • [www.beleduc.de](http://www.beleduc.de)

**Âge:** 12 mois et plus

**Joueur:** 1 et plus

**Taille:** 1 177 x 700 x 12 mm (porte), 700 x 600 x 12 mm (tous les autres éléments)

Les différents éléments sont conçus pour être montés par un adulte.



## Panel para parque „Burg“

Con nuestros 6 nuevos paneles «Burg», incluso los más pequeños pueden descubrir la «vida medieval» de la forma más divertida. Cada panel ofrece muchas funciones diferentes que estimulan las habilidades de los niños gracias a su atractivo diseño. Ya sea formando un círculo (con los 6 paneles unidos) o de tres en tres, ofrecemos 3 posibilidades de montaje diferentes en función del espacio disponible. También es posible su anclaje a la pared con un kit adicional. El panel para parque «Burg» es adecuado para su uso en centros infantiles y salas de espera o para grupos. Los paneles han sido concebidos teniendo en cuenta el desarrollo de los niños en edad temprana y aún la diversión con el desarrollo educativo. Ofrecen un montón de cosas para descubrir y no ponen ningún límite a la fantasía de los niños. Tanto si se disponen a la caza y captura de los pequeños fantasmas del castillo como si buscan divertirse con música en el castillo, aquí pueden dar rienda suelta a su imaginación.

Todas las piezas deben quedar fijadas correctamente e inspeccionarse periódicamente. De lo contrario, podrían soltarse o suponer otros peligros. • beleduc Lernspielwaren GmbH • www.beleduc.de

Edades: 12+ meses

Jugadores: 1+

Medidas: 1177 x 700 x 12 mm (puerta), 700 x 600 x 12 mm (todos los paneles anchos)

Los distintos paneles están diseñados para su montaje por un adulto.



## crèche element „kasteel“

Met onze 6 nieuwe „kasteel“-elementen kunnen de kleinste kinderen het „kasteelleven“ al op een speelse wijze ontdekken. Ieder element biedt een groot aantal zeer uiteenlopende functies, die door hun attractieve vormgeving veel van de intelligentie en de fantasie van de kinderen vergen. Of als rondeel (alle 6 elementen samen) of als combinatie van 3 delen opgesteld, al naargelang de plaatsruimte bieden we 3 verschillende opbouw mogelijkheden aan. Ook een bevestiging aan de muur is met een extra set mogelijk. Het crèche element „kasteel“ is zeer geschikt voor het gebruik in inrichtingen voor kinderen en verblijfs- en groepsruimtes. De elementen werden met inachtneming van de vroege ontwikkeling van kinderen ontworpen en verenigen speelplezier en educatieve verdere ontwikkeling. Hier valt er veel te ontdekken. De kinderen kunnen hun fantasie vrij uitleven. Of ze nu op jacht gaan naar kleine kasteelspoken of voor muzikaal amusement op het kasteel zorgen, hier kunnen ze zich vrij ontplooiën.

Alle onderdelen moeten vakkundig gefixeerd en regelmatig gecontroleerd worden. Anders kunnen ze los gaan zitten of op andere wijze gevaarlijk worden. • beleduc Lernspielwaren GmbH • www.beleduc.de

Leeftijd: 12M+

Spelers: 1+

Formaat: 1177 x 700 x 12 mm (deur), 700 x 600 x 12 mm (alle andere elementen)

De afzonderlijke elementen zijn bedoeld voor een montage door een volwassen persoon.



## Elemento prima infanzia “Castello”

Con i nostri 6 nuovi prodotti “Castello” anche i bambini più piccoli possono scoprire la “vita del castello” durante il gioco. Ogni elemento offre una molteplicità di funzionalità variegata, che grazie al loro interessante design integra un carattere d’esorizzazione elevato per i bambini. Sia in forma di un bastione circolare (una combinazione di tutti i 6 elementi), che di una costruzione con 3 elementi, a seconda dello spazio a disposizione, offriamo 3 diverse possibilità di costruzione. Gli elementi possono anche essere fissati su una parete utilizzando l’apposito set supplementare. L’elemento prima infanzia “Castello” è particolarmente adatto per essere usato in istituti per l’infanzia e in locali per gruppi o sale di attesa. Gli elementi sono stati concepiti in conformità allo sviluppo infantile e combinano divertimento di gioco e sviluppo educativo. Offrono tantissime cose da scoprire, senza porre nessun limite alla fantasia dei bambini. Sia alla caccia di piccoli fantasmi nel castello, che fornendo l’intrattenimento musicale a corte, qui i bambini possono svilupparsi liberamente.

Alle onderdelen moeten vakkundig gefixeerd en regelmatig gecontroleerd worden. Anders kunnen ze los gaan zitten of op andere wijze gevaarlijk worden. • beleduc Lernspielwaren GmbH • www.beleduc.de

Età: 12+ mesi

Giocatore: 1+

Dimensioni: 1177 x 700 x 12 mm (porta), 700 x 600 x 12 mm (tutti gli altri elementi)

I singoli elementi sono concepiti per il montaggio da parte di una persona adulta.



## 墙面游戏城堡

我们全新的墙面游戏-城堡，包含有6个主要部件，可以让包括低年龄段幼儿在内在的所有小朋友都能探索体验“城堡内的生活”。每一个城堡部件都有着十分吸引人的外观设计，不同的游戏功能可以培养锻炼孩子们的各种技能。墙面游戏-城堡可以用6个主要部件围成一个圆环，也可用3个不同部件组合摆放。一般根据不同的空间情况，这款产品可以组合成3种不同结构模式。另外，也可以利用连接件将整个城堡安装到墙面上去。我们的墙面游戏-城堡非常适合在幼儿园、托儿所、儿童娱乐中心、团体活动室等游戏场所中使用。这款游戏产品是为儿童早期智力开发设计的，体现了贝乐多一贯坚持“让孩子们在快乐游戏中学习”的设计理念。孩子们的想象力是完全不受限制的，在游戏中有许许多多的东西等待着他们去探索发现，无论是追逐城堡幽灵，还是弹奏美妙的音乐来款待城堡居民。。。这些都带给人们无限的遐想！

为避免产品从墙面上脱落或者出现其他可能造成危险的状态，所有部件要求正确安装并定期检查。贝乐多工艺品（宁波）有限公司 www.beleduc-nb.com

年龄组：12个月以上

游戏人数：1人以上

尺寸：1177 x 700 x 12 mm (部件门), 700 x 600 x 12 mm (其他城堡部件)

每个墙面游戏城堡部件都需由成人安装。







### „Tür-Element“

Burgtore sind häufig mit einem großen Klopfer versehen. Das Guckloch hilft dabei, nur gebetenen Besuchern Eintritt zu gewähren. Freunden wird das „Burgtor“ geöffnet.

**Funktionen:**

- Türklopfer
- Guckloch
- Vorhang

**Förderung:**

- Feinmotorik
- Phantasie, Vorstellungsvermögen
- Kommunikation, Erzählfreude
- Freies Rollenspiel



### „Motorik-Element“

Hier können mutige Ritter auf Geisterjagd gehen und sie mit Hilfe des Drachens in die Flucht schlagen.

**Funktionen:**

- drehbare Sonne
- Prismenfenster
- drehbarer Ritterkopf
- bewegliche Ritter / Geister

**Förderung:**

- Feinmotorik
- Auge-Hand-Koordination
- Phantasie, Erzählfreude
- Formerkennung
- Geschicklichkeit



### „Drehscheiben-Element“

Ob Prinzessin, Ritter, Drache und Co., alle leben gemeinsam auf der Burg und immer schaut jemand anderes aus den Burgmauern hervor.

**Funktionen:**

- Drehscheibe mit Spiraldruck
- Fenster mit wechselnden Motiven

**Förderung:**

- Auge-Hand-Koordination
- Phantasie
- Erzählfreude







## „Musik-Element“

Auch für die musikalische Unterhaltung des Hofvolkes wird gesorgt. Kombiniert man alle 3 Instrumente miteinander, entstehen einzigartige „Musikstücke“.

### Funktionen:

- Klangstäbe
- Tamburin
- Kugeltrommel

### Förderung:

- Auditive Wahrnehmung
- Feinmotorik
- Kreativität
- Hörvermögen

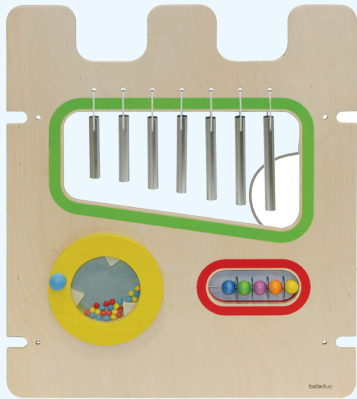

## „Clown-Element“

Der Hofnarr sorgt für Unterhaltung und Belustigung am Hof. Mit seinen Fühl- und Geräuschaccessoires zieht er die Blicke auf sich.

### Funktionen:

- Fühl-/Geräuschbälle
- Fühl-/Geräuschkragen mit: Knisterfolie, Rassel, Plastikkügelchen, Quietschball

### Förderung:

- Auditive Wahrnehmung
- Taktile Wahrnehmung
- Hörvermögen

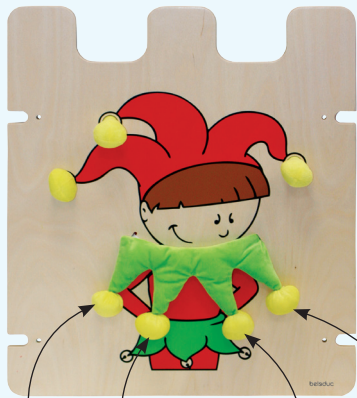

## „Spiegel-Element“

Vor allem für die Prinzessin gibt es in Burgen viele Spiegel. Diese sind etwas aus der Art geraten und lassen lustige Körperformen entstehen. So wirkt der Betrachter einmal dicker und ein anderes Mal dünner.

### Funktionen:

- 2 Spiegelseiten: Konvex, Konkav

### Förderung:

- visuelle Wahrnehmung
- Wahrnehmung des eigenen Ich's





### „Door Element“

Castle entrances often have a large doorknocker. The peephole helps to make sure that only welcome guests are admitted. The “castle gate” is only thrown open to friends.

**Function:**

- Doorknocker
- Peephole
- Curtain

**Helps develop:**

- Fine motor skills
- Imagination
- Free role play
- Fantasy
- Communication
- Enjoyment of story-telling



### „Motor Element“

Here brave knights can go hunting for ghosts and put them to flight with the help of the dragon.

**Function:**

- Revolving sun
- Prism window
- Knight’s head can be turned
- Movable knight / ghosts

**Helps develop:**

- Fine motor skills
- Fantasy
- Shape recognition
- Visual perception
- Hand-to-eye coordination
- Enjoyment of story-telling
- Dexterity



### „Turntable Element“

Princess, knight, dragon and company - they all live together in the castle and there’s always someone else looking out from the castle walls.

**Function:**

- Wheel with spiral print
- Window with changing motifs

**Helps develop:**

- Hand-to-eye coordination
- Imagination
- Enjoyment of story-telling





### „Musik Element“

The castle inhabitants also have musical entertainment. When all three instruments are combined, unique “music compositions” are created.

**Function:**

- Claves
- Tambourine
- Drum

**Helps develop:**

- Auditory perception
- Creativity
- Fine motor skills
- Hearing

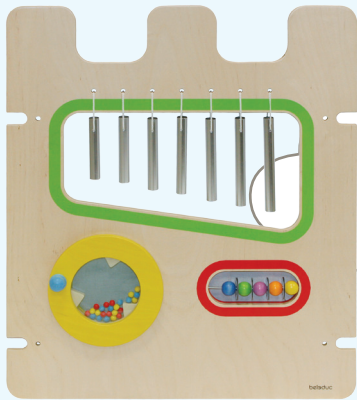

### „Clown Element“

The court jester provides amusement and entertains the assembled company. He attracts attention with his touch-and-sound accessories.

**Function:**

- Touch-and-sound balls
- Touch-and-sound ‘apron’
- filled with: crackle foil/ small plastic balls / squeaky ball / little bell

**Helps develop:**

- Auditory perception
- Tactile perception
- Powers of hearing

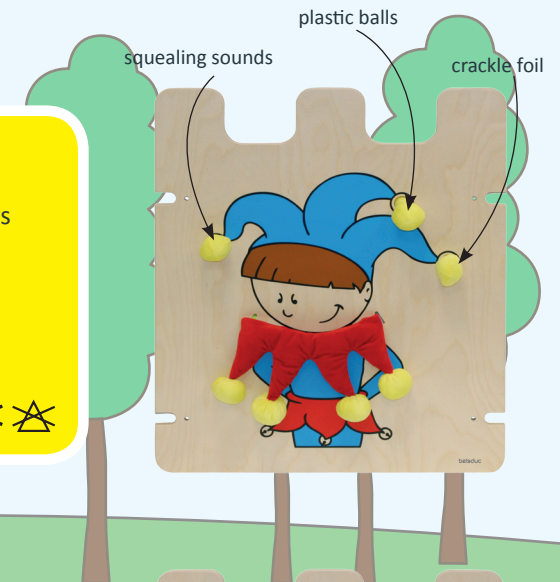
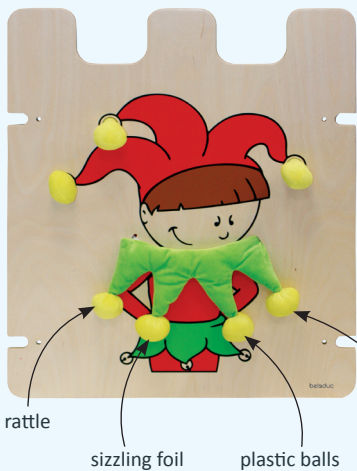

### „Mirror Element“

The mirrors in the castle are sure to please the princess. They seem to be a bit odd and they make people’s bodies into funny shapes. Sometimes the person in front of the mirror looks thinner - and sometimes fatter.

**Function:**

- 2 sides of mirror: convex /concave

**Helps develop:**

- Visual perception
- Perception of the “self”

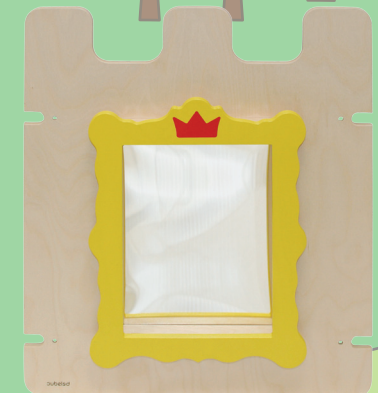





### „Élément Porte“

Les portes des châteaux forts sont souvent munies d'un gros heurtoir. Le judas permet de ne faire entrer que les visiteurs désirés. Il est possible « d'ouvrir la porte » aux amis.

**Fonction:**

- Heurtoir de porte
- Judas
- Rideau

**Stimulation:**

- Motricité fine
- Capacité d'imagination
- Plaisir de raconter
- Imaginaire
- Communication
- Jeu de rôles libre



### „Élément pour la motricité“

Les distractions musicales pour les membres de la cour ne sont pas non plus oubliées. Si l'on combine les trois instruments, l'on découvre des « morceaux de musique » uniques en leur genre.

**Fonction:**

- Soleil pivotant
- Fenêtre à prismes
- Tête tournante de chevalier
- Chevaliers/Fantômes mobiles

**Stimulation:**

- Motricité fine
- Imagination
- Habileté
- Reconnaissance des formes
- Coordination œil-main
- Plaisir de raconter
- Perception visuelle



### „Élément Disque tournant“

Princesse, chevalier, dragon et compagnie, tous vivent ensemble dans le château fort et regarde chacun à son tour par-dessus les murailles.

**Fonction:**

- Disque tournant avec motifs en spirale
- Fenêtre avec motifs alternants

**Stimulation:**

- Coordination œil-main
- Imagination
- Plaisir de raconter





## „Élément Musique “

Les distractions musicales pour les membres de la cour ne sont pas non plus oubliées. Si l'on combine les trois instruments, l'on découvre des « morceaux de musique » uniques en leur genre.

### **Fonction:**

- Xylophone
- Tambourin
- Tambour boule

### **Stimulation:**

- Auditive Wahrnehmung
- Feinmotorik
- Kreativität
- Hörvermögen

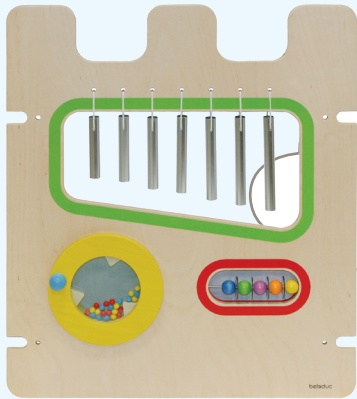

## „Élément Clown “

À la cour, le bouffon était chargé de distraire et d'amuser les gens. Avec ses accessoires tactiles et sonores, il attire tous les regards.

### **Fonction:**

- Boules tactiles/sonores
- Collet tactile/sonore
- rempli de : Film crépissant / Billes de plastique  
Boule qui couine / Clochettes

### **Stimulation :**

- Perception auditive
- Perception tactile
- Capacité auditive

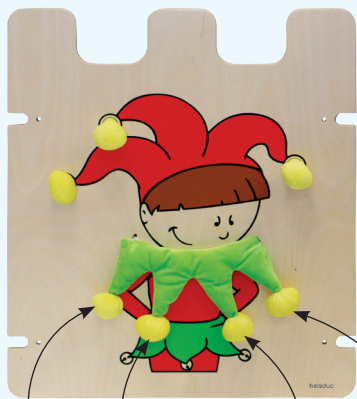

hochet  
grésillements  
balles en plastique  
sons aigus

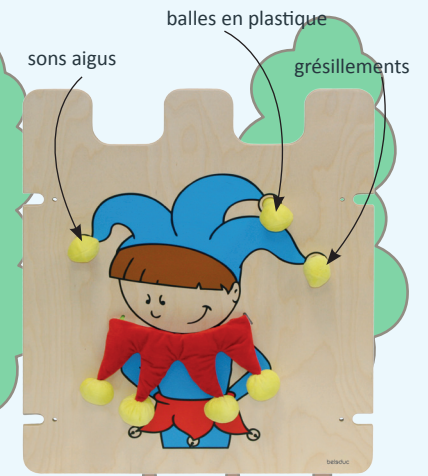

sons aigus  
balles en plastique  
grésillements

## „Élément Miroir “

Ce sont surtout les princesses qui, dans les châteaux, ont besoin de beaucoup de miroirs. Ceux-ci sont un peu différents des miroirs habituels et font naître des formes bizarres. Le spectateur est parfois gros, parfois tout mince.

### **Fonction:**

- 2 faces de miroir : Convexe / Concave

### **Stimulation:**

- Perception visuelle
- Perception de « soi-même »

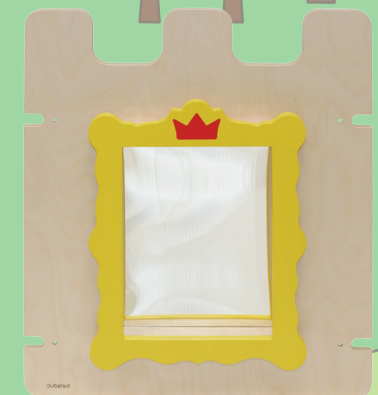



### „Panel de puerta“

Las puertas de los castillos cuentan muchas veces con una gran aldaba. La mirilla ayuda a franquear el paso sólo a los visitantes bienvenidos. Los amigos pueden pasar por la «puerta del castillo».

**Función:**

- Aldaba
- Mirilla
- Cortina

**Fomenta:**

- Coordinación motora fina
- Imaginación
- Capacidades interpretativas
- Gusto por la narración
- Juegos de rol libres
- Comunicación



### „Panel de coordinación motora“

Con él los valientes caballeros pueden emprender la caza de los fantasmas y ahuyentarlos con ayuda del dragón.

**Función:**

- Sol giratorio
- Ventana de prisma
- Cabeza de caballero giratoria
- Caballero / fantasma móviles

**Fomenta:**

- Coordinación motora fina
- Destreza
- Coordinación ojo-mano
- Imaginación
- Identificación de formas
- Percepción visual
- Gusto por la narración



### „Panel de disco giratorio“

Princesas, caballeros, dragones y más conviven en el castillo y en cada momento es uno u otro el que asoma por las almenas del castillo.

**Función:**

- Disco giratorio con impresión en espiral
- Ventanas con motivos cambiantes

**Fomenta:**

- Coordinación ojo-mano
- Imaginación
- Gusto por la narración







### „Panel musical“

Auch für die musikalische Unterhaltung des Hofvolkes wird gesorgt. Kombiniert man alle 3 Instrumente miteinander, entstehen einzigartige „Musikstücke“.

**Función:**

- Xilófono
- Pandereta
- Tambor de bolas

**Fomenta:**

- Percepción auditiva
- Coordinación motora fina
- Creatividad
- Capacidad auditiva

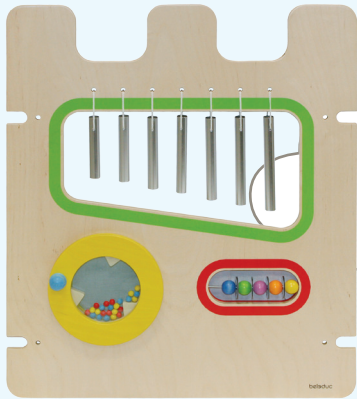

### „Panel de bufón“

Del entretenimiento y la diversión en la corte se encarga nuestro juglar. Con sus accesorios táctiles y sonoros, se convierte en el blanco de todas las miradas.

**Función:**

- Bolas táctiles y sonoras
- Cuello táctil y sonoro
- Relleno de: Lámina crepitante, Bolitas de plástico, Bola de chirridos, Campanilla

**Fomenta:**

- Percepción auditiva
- Percepción táctil
- Capacidad auditiva

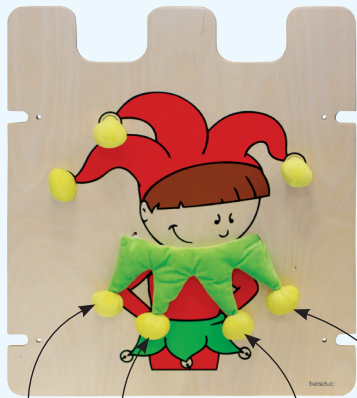

sonajero  
papel celofán  
bolas de plástico  
chirridos



bolas de plástico  
chirridos  
papel celofán

### „Panel de espejo“

Todo buen castillo frece numerosos espejos, especialmente pensando en la princesa. Estos se salen un poco de lo habitual y transforman de manera divertida a quien los usa. Por ejemplo, quien se asoma a ellos se ve más grueso o más flaco.

**Función:**

- Espejo de 2 caras:
- Convexa
  - Cóncava

**Fomenta:**

- Percepción visual
- Percepción de uno mismo

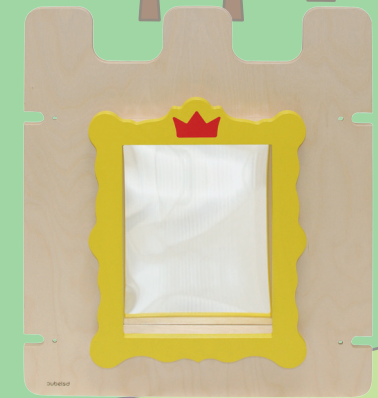



### „Deur-element“

Kasteelpoorten hebben vaak een grote klopper. Het kijkgat helpt om alleen welkome bezoekers binnen te laten. Voor vrienden wordt de „kasteelpoort“ geopend.

**Functie:**

- Deurklopper
- Kijkgat
- Gordijn

**Stimulering:**

- Fijne motoriek
- Voorstellingsvermogen
- Plezier bij het vertellen
- Fantasie
- Communicatie
- Vrij rollenspel



### „Motoriek-element“

Hier kunnen moedige ridders op spokenjacht gaan en hen met behulp van de draak op de vlucht slaan.

**Functie:**

- Draaibare zon
- Prismavenster
- Draaibaar ridderhoofd
- Beweeglijke ridders / spoken

**Stimulering:**

- Ffijnmotoriek
- Phantasie
- Herkennen van de vorm
- Visuele waarneming
- Oog-hand-coördinatie
- Plezier bij het vertellen
- Handigheid



### „Draaischijf-element“

Op prinses, ridder, draak enz., ze wonen allemaal samen op het kasteel en steeds kijkt iemand anders uit de kasteelmuren naar buiten.

**Functie:**

- Draaischijf met spiraal print
- Venster met wisselende motieven

**Stimulering:**

- Oog-hand-coördinatie
- Fantasie
- Plezier bij het vertellen





### „Muziek-element“

Ook voor het muzikale element van de hofbewoners wordt gezorgd. Combineert men alle 3 instrumenten met elkaar, ontstaan unieke „muziekstukken“.

**Functie:**

- Klankstaven
- Tamboerijn
- Kogeltrommel

**Stimulering:**

- Auditieve waarneming
- Fijne motoriek
- Creativiteit
- Geheeromogen

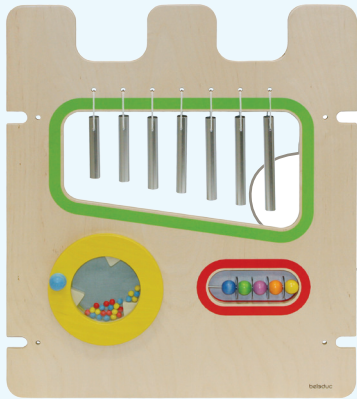

### „Clown-element“

De hofnar zorgt voor amusement en vermaak aan het hof. Met zijn voel- en geluidsaccessoires trekt hij alle blikken aan.

**Functie:**

- Voel-/geluidsballen
- Voel-/geluidskraag
- gevuld met: ritselende folie / piepende bal / Klokjes / plastic kogeltjes

**Stimulering:**

- Auditieve waarneming
- Tactiele waarneming
- Geheeromogen

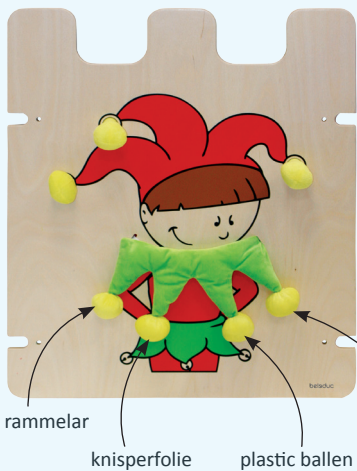

### „Spiegel-element“

Vooral voor de prinses zijn er in kastelen veel spiegels. Deze zien er toch wel anders uit dan normale spiegels en laten grappige lichaamsvormen ontstaan. Zo ziet de kijker er de ene keer wat dikker en de volgende keer wat dunner uit.

**Functie:**

- 2 spiegelzijden: convex / concaaf

**Stimulering:**

- Visuele waarneming
- Waarneming van het eigen ik

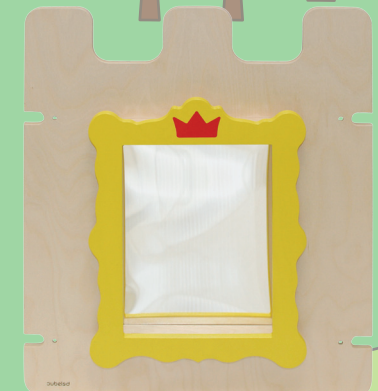





### „Elemento porta“

Le porte del castello sono spesso provviste di un grande battitore. La spia aiuta a far entrare solo ospiti invitati. La “porta” viene aperta agli amici.

**Funzione:**

- Battitore
- Spia
- Tenda

**Stimolazione:**

- Motricità fine
- Fantasia
- Libero gioco delle parti
- Comunicazione
- Immaginazione
- Voglia di raccontare



### „Elemento di attività motoria“

Qui i cavalieri coraggiosi possono andare alla caccia di fantasmi e metterli in fuga con l'aiuto del drago.

**Funzione:**

- Sole girevole
- Finestra con prismi
- Testa del cavaliere girevole
- Cavaliere / fantasma mobili

**Stimolazione:**

- Motricità fine
- Fantasia
- Percezione visiva
- Coordinazione occhio - mano
- Destrezza
- Voglia di raccontare
- Riconoscimento di forme



### „Elemento piattaforma rotante“

Principessa, cavaliere, drago e Co., tutti vivono insieme nel castello e c'è sempre qualcuno che fa capolino dalle sue mura.

**Funzione:**

- Piattaforma rotante con pressione a spirale
- Finestra con motivi mutevoli

**Stimolazione:**

- Coordinazione occhio - mano
- Voglia di raccontare
- Fantasia





## „Elemento musicale“

Non ci siamo scordati l'intrattenimento musicale della corte. Combinando i 3 strumenti si ottengono "pezzi musicali" del tutto unici.

### Funzione:

- Xilofono
- Tamburino
- Tamburo tondo

### Stimolazione:

- Percezione uditiva
- Creatività
- Motricità fine
- Udito

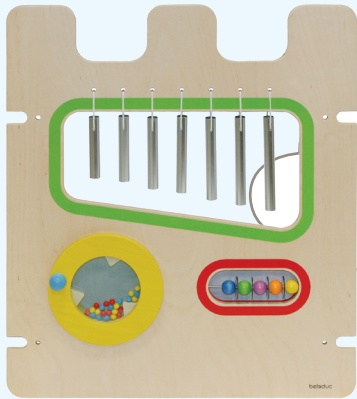

## „Elemento giullare di corte“

Il giullare di corte ha il compito di intrattenere e far divertire. Attrae tutti gli sguardi grazie ai suoi accessori tattili e sonori.

### Funzione:

- Palline tattili / sonore
- Collo tattile / sonoro
- contenente: pellicola fruscante/perline di plastica  
palla sonora/ campanellini

### Stimolazione:

- Percezione uditiva
- Percezione tattile
- Udito

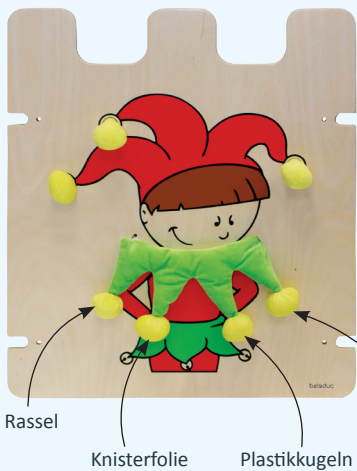

## „Elemento specchio“

Vor allem für die Prinzessin gibt es in Burgen viele Spiegel. Diese sind etwas aus der Art geraten und lassen lustige Körperformen entstehen. So wirkt der Betrachter einmal dicker und ein anderes Mal dünner.

### Funzione:

- 2 lati dello specchio: convesso / concavo

### Stimolazione:

- Percezione visiva
- Percezione di se stessi

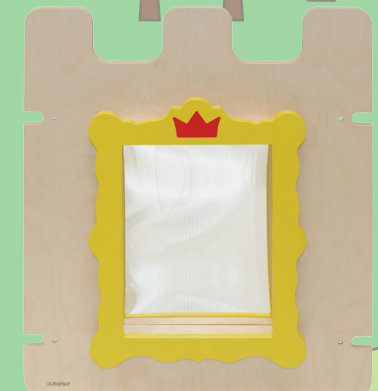



### “墙面游戏城堡-城门”

城堡的大门通常有一个很大的门铃。大门上的窥探孔是用来查看进来的人是否受到欢迎的，城堡的大门一般只对好朋友才会敞开的哦！

#### 功能:

- 门铃
- 窥探孔
- 帘子

#### 能力培养:

- 手指精细动作
- 想象力
- 讲故事能力
- 憧憬梦想
- 沟通能力
- 自由角色扮演



### “墙面游戏城堡 -运动部件”

只有勇敢的骑士才能追捕幽灵，并在龙的帮助下一起将它们全部赶跑。

#### 功能:

- 可旋转的太阳
- 万花筒窗户
- 骑士的头可以转动
- 可移动的骑士和幽灵

#### 能力培养:

- 手指精细动作
- 手眼协调
- 讲故事能力
- 动作灵活性
- 憧憬梦想
- 形状认知
- 视觉感官



### “墙面游戏城堡 - 转盘部件”

公主，骑士，龙和女仆一起住在城堡里，他们时常会从城墙上好奇的探出头来向外看看。

#### 功能:

- 方向盘可转动
- 窗户可变换图案

#### 能力培养:

- 手眼协调能力
- 想象力
- 讲故事能力



每个墙面游戏城堡部件都需由成人安装。为避免产品从墙面上脱落或者出现其他可能造成危险的状态，所有部件要求正确安装并定期检查。





### “墙面游戏城堡 - 音乐部件”

在这里，城堡的居民可以享受音乐的盛会。当三组乐器组合起来演奏，独一无二的“音乐大餐”马上就可以开始啦！

#### 功能:

- 音乐棒
- 铃鼓
- 鼓

#### 能力培养:

- 音乐感知
- 手指精细动作
- 创造力
- 听觉

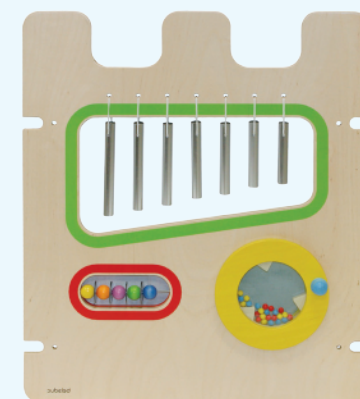
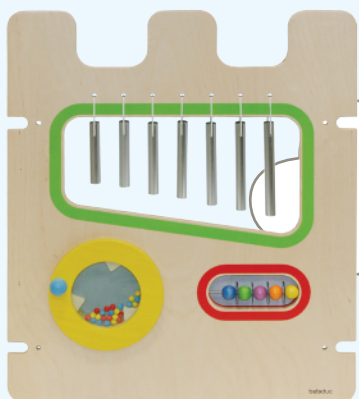

### “墙面游戏城堡 - 小丑部件”

这个宫廷小丑通过头上的各个发声配件吸引着所有小朋友的注意，给周围的伙伴们带来了无穷的快乐和欢笑！

#### 功能:

- 发声小球
- 发声围裙
- 填充物：响纸 / 塑料颗粒 / 叫叫球 / 小铃铛

#### 能力培养:

- 音乐感知
- 触觉感知
- 听力



### “墙面游戏城堡 - 镜子部件”

城堡里的镜子绝对能取悦于公主。这面镜子看起来有点古怪，它可以把人的身体变成十分滑稽的形状。小朋友站在镜子前面，有时候看起来很瘦长，有时候又能变得很肥胖。

#### 功能:

- 双面镜：凸面镜  
凹面镜

#### 能力培养:

- 视觉感知
- 自我感知



每个墙面游戏城堡部件都需由成人安装。为避免产品从墙面上脱落或者出现其他可能造成危险的状态，所有部件要求正确安装并定期检查。

# Überblick

Overview / Aperçu / Vista general / Overzicht / Panoramica / 平面结构

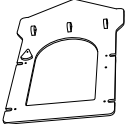
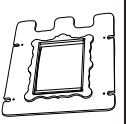
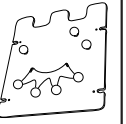
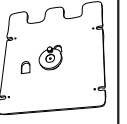
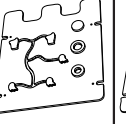
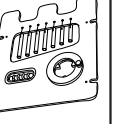
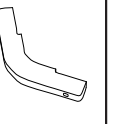
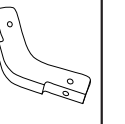
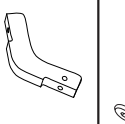
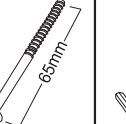
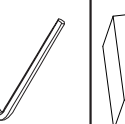
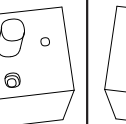
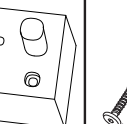
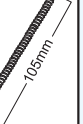
														
	(a)	(b)	(c)	(d)	(e)	(f)	(g)	(h)	(i)	(j)	(k)	(l)	(m)	(n)
27003 Krippenelement „Burg“ Set 1 27003 Floor Element “Castle” Set 1 Structure: A Rondell / rondel	1x	1x	1x	1x	1x	1x	12x	12x		24x	1x			
27003 Krippenelement „Burg“ Set 1 27003 Floor Element “Castle” Set 1 Structure: B Knochenform bone	1x	1x	1x	1x	1x	1x	2x	2x	12x	16x	1x			
27003 Krippenelement „Burg“ Set 1 27003 Floor Element “Castle” Set 1 Structure: C 2 x Stern-Form / 2 x star (see 27004/27005) 27003 + 27007	1x	1x	1x	1x	1x	1x			12x	12x	1x			
Krippenelement „Burg“ Wandbefestigung 27003 + 27007 Floor Element „Castle“ Wall fixation	1x	1x	1x	1x	1x	1x					1x	12x	12x	48x
27004 Krippenelement „Burg“ Set 2 27004 Floor Element “Castle” Set 2	1x				1x	1x			6x	6x	1x			
27005 Krippenelement “Burg” Set 3 27005 Floor Element “Castle” Set 3		1x	1x	1x					6x	6x	1x			

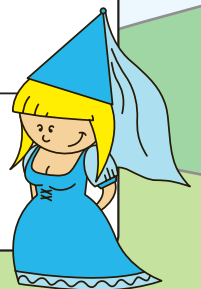

27003 Krippenelement „Burg“ Set 1/ Struktur A/ Rondell  
 27003 Floor Element “Castle” Set 1/ Structure A/ rondel

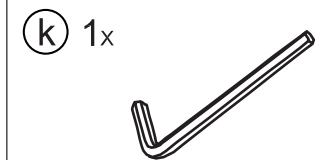
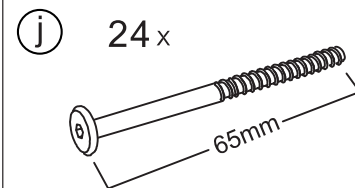
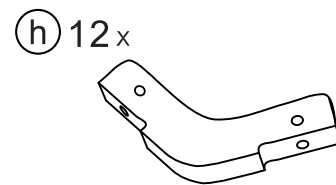
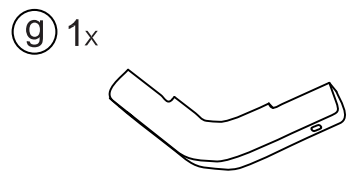
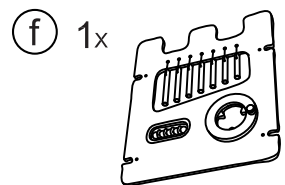
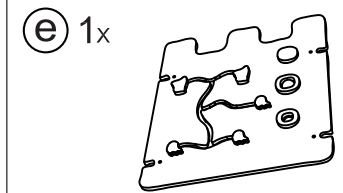
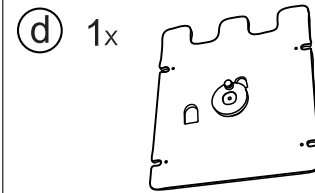
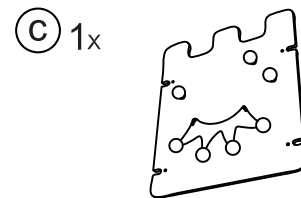
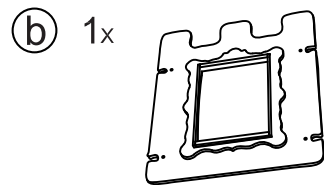
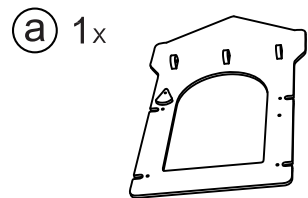
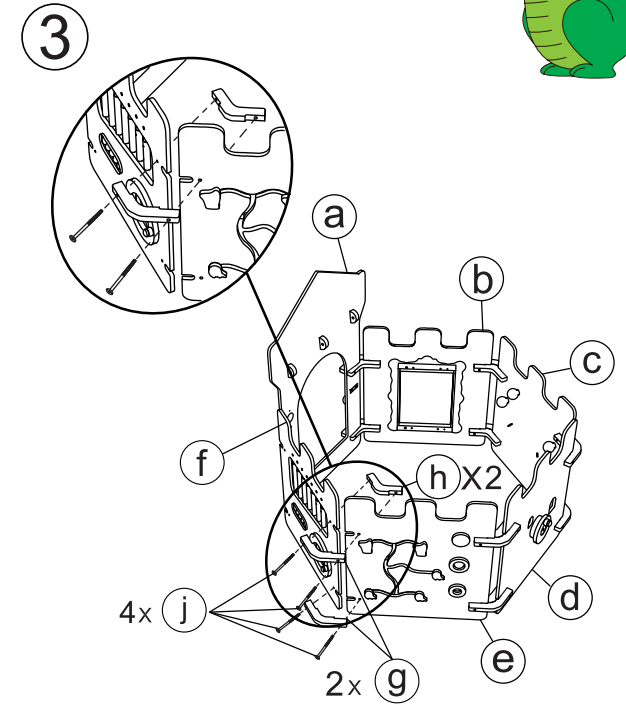
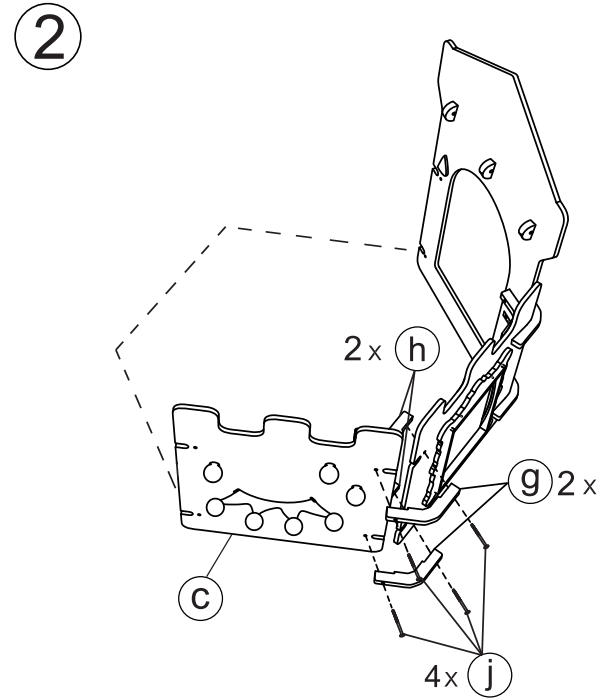
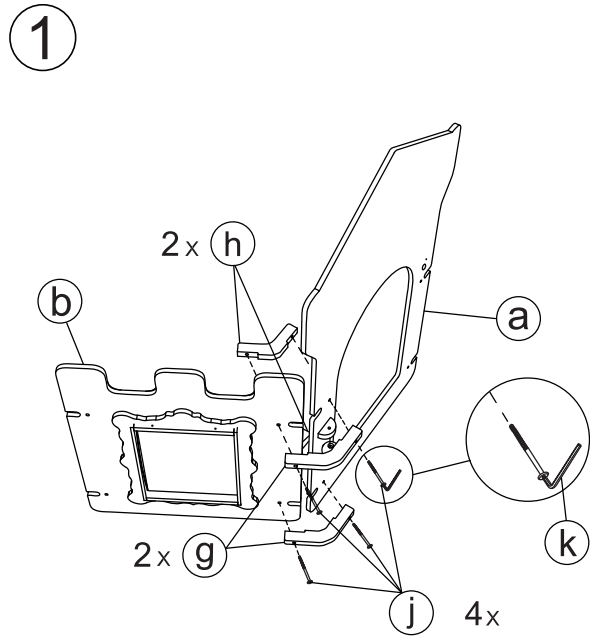
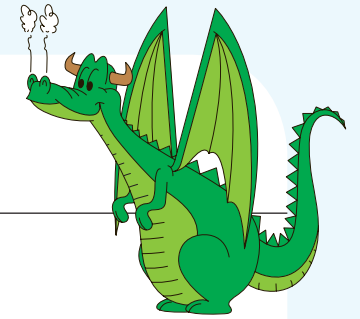



# 27003 Krippenelement „Burg“ Set 1/ Struktur B/ Knochenform

## 27003 Floor Element “Castle” Set 1/ Structure B/ bone

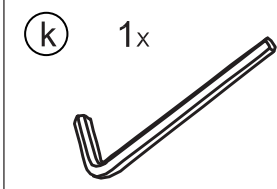
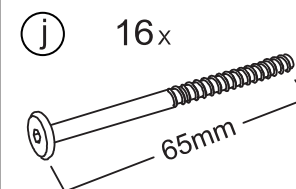
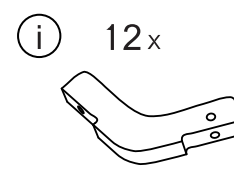
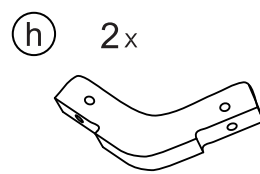
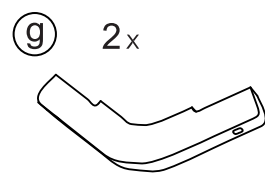
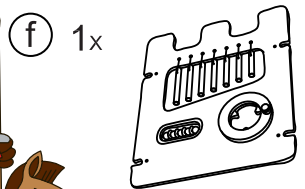
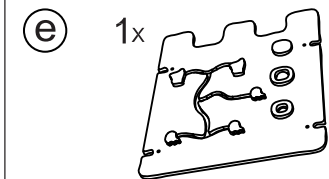
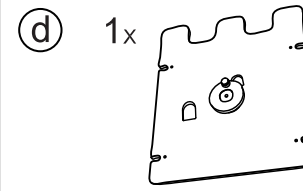
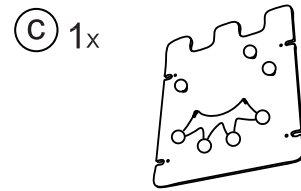
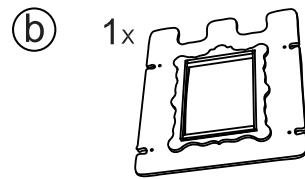
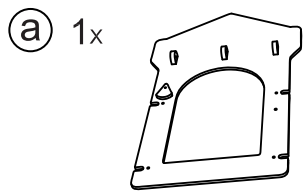
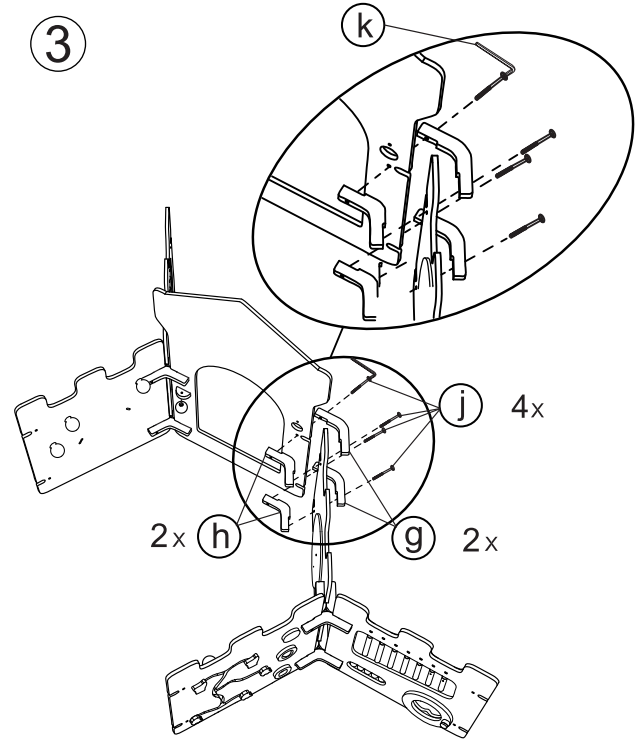
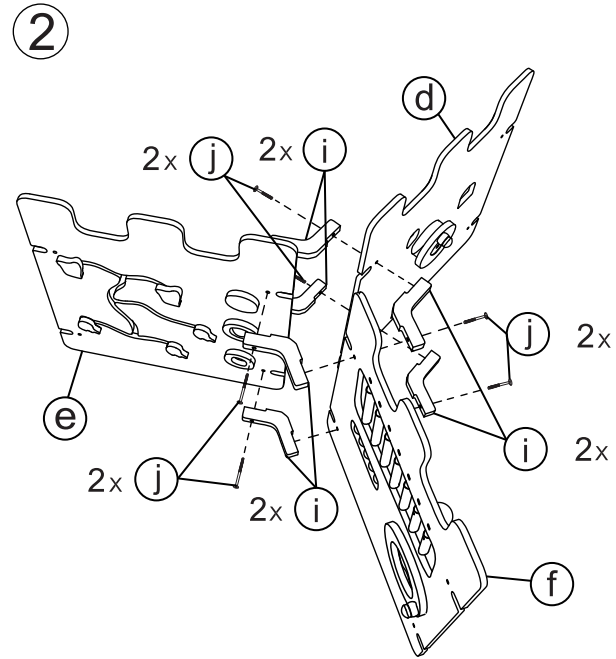
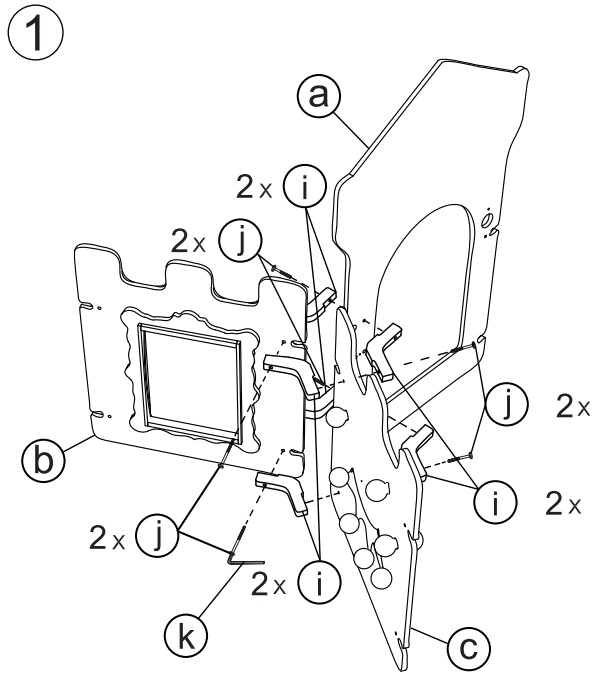

713324 v01 121212

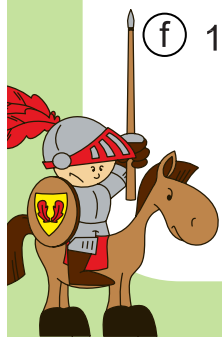

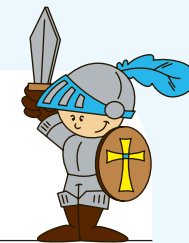

# 27003 + 27007 Krippenelement „Burg“ Wandbefestigung

## 27003 + 27007 Floor Element „Castle“ Wall fixation

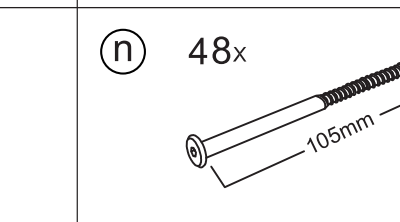
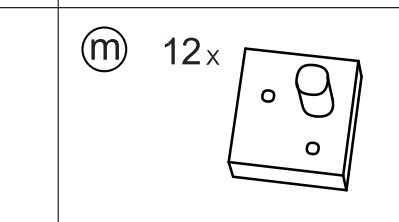
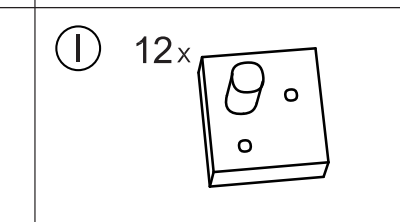
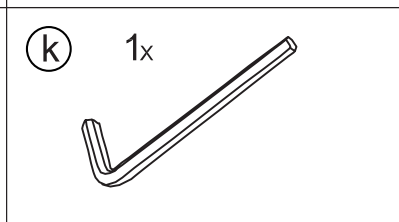
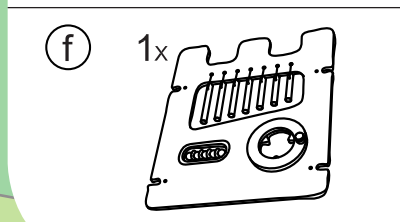
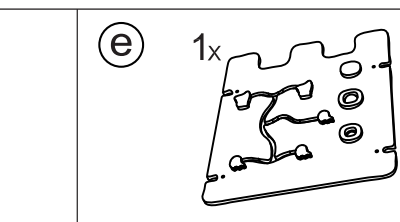
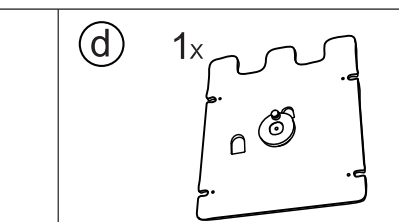
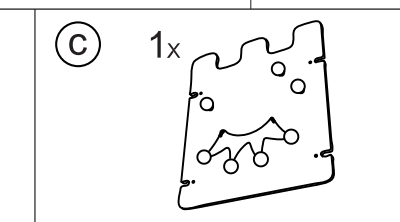
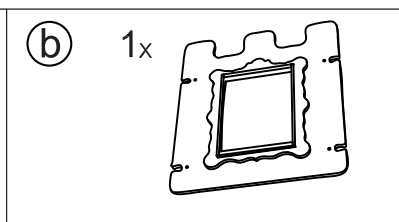
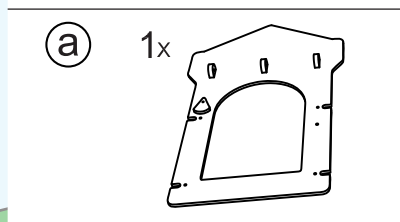
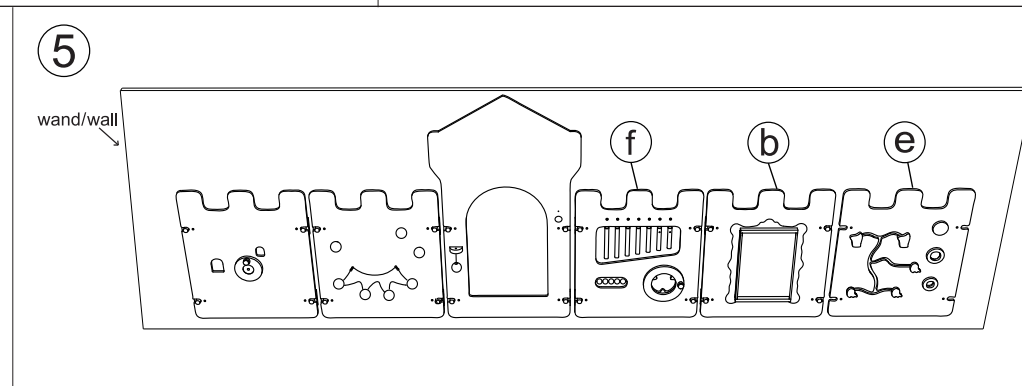
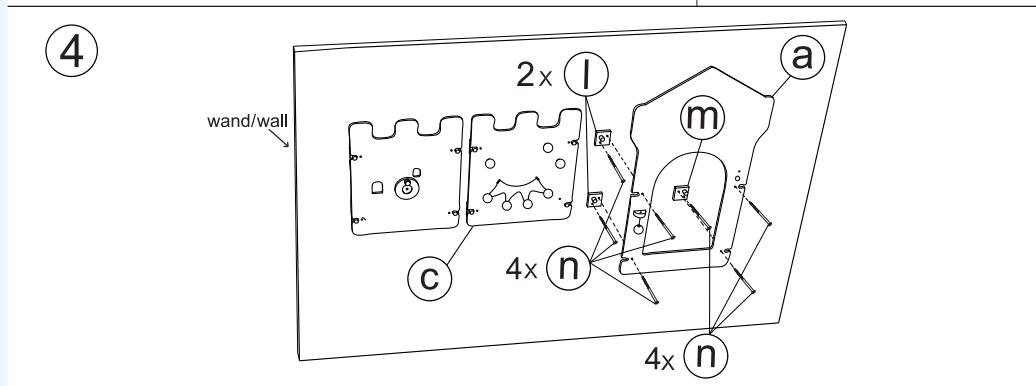
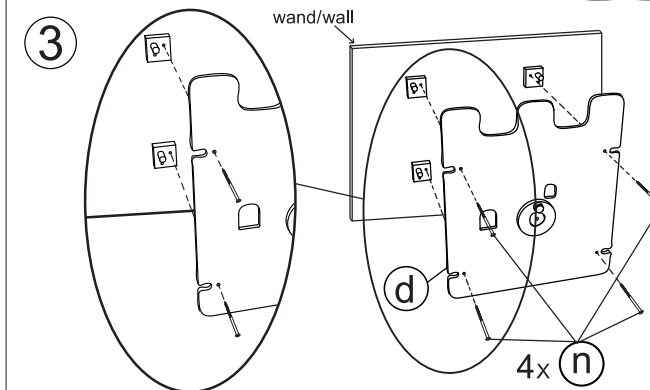
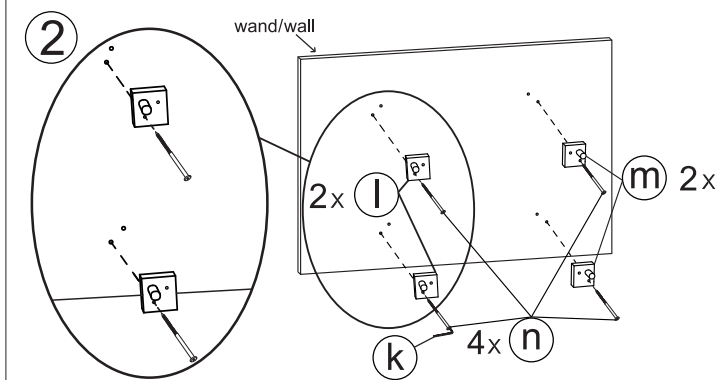
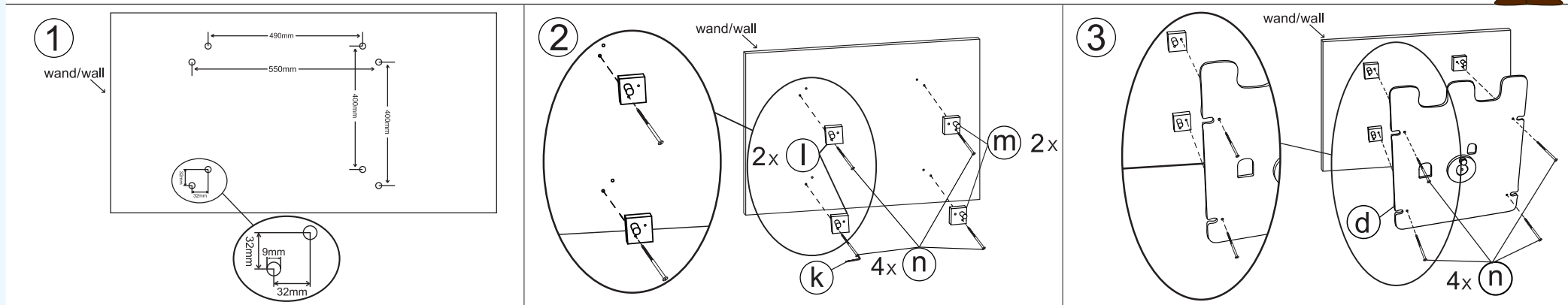



# 27004 Krippenelement „Burg“ Set 2

## 27004 Floor Element “Castle” Set 2

1

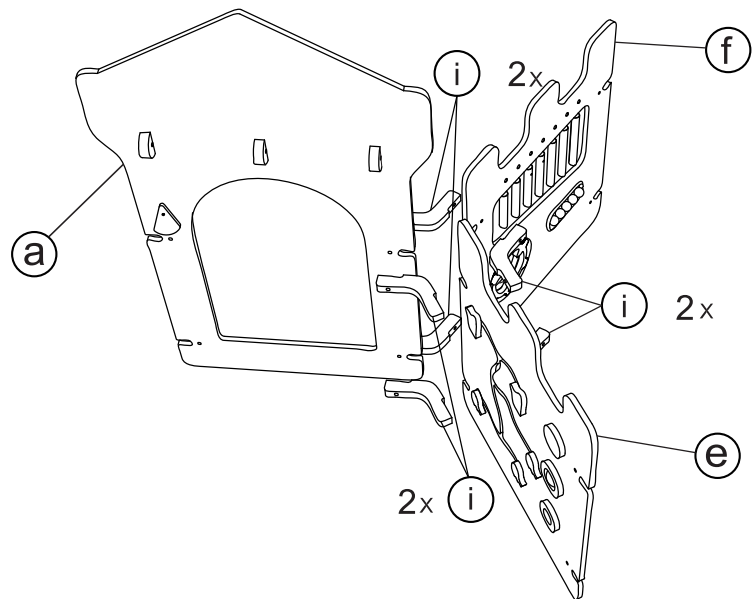

2

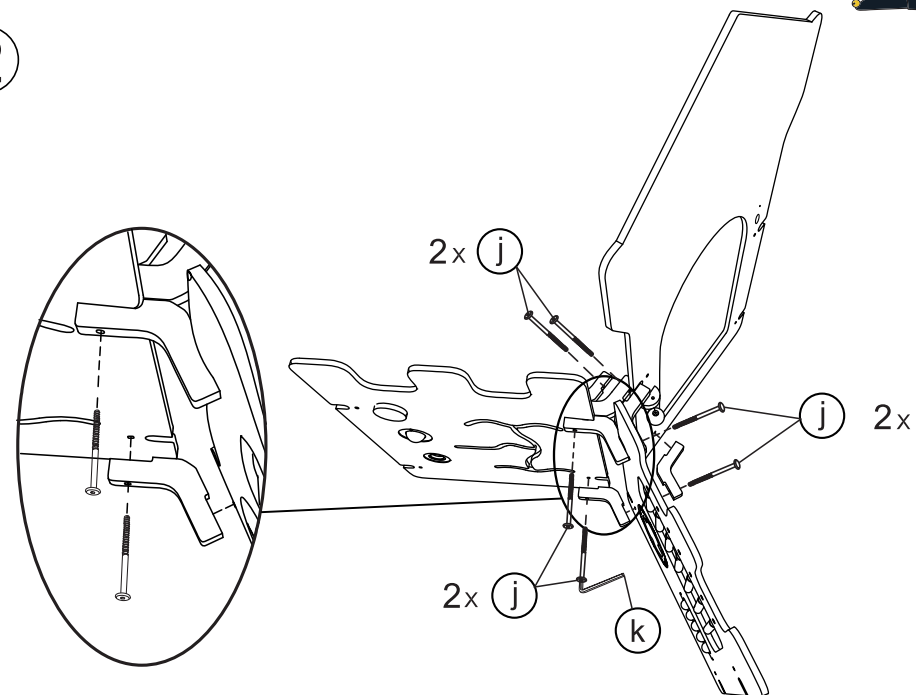

a 1x

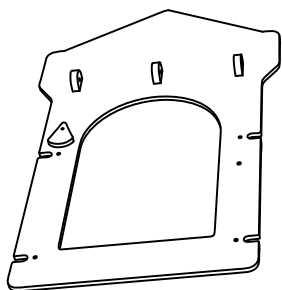

e 1x

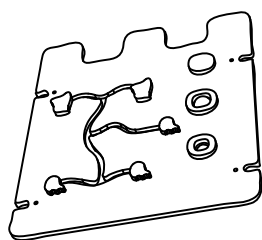

f 1x

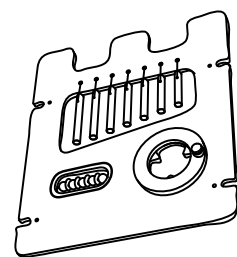

i 6x

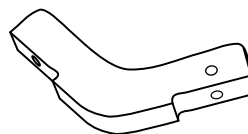

j 6x

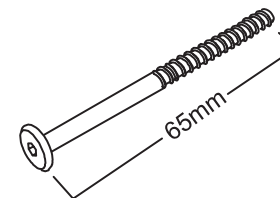

k 1x

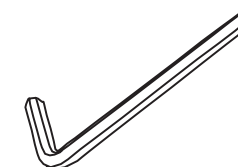



# 27005 Krippenelement "Burg" Set 3

## 27005 Floor Element "Castle" Set 3

1

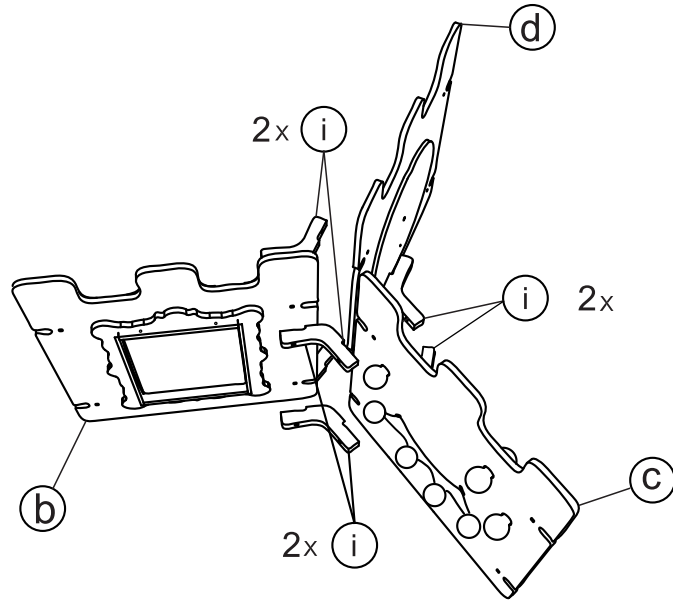

2

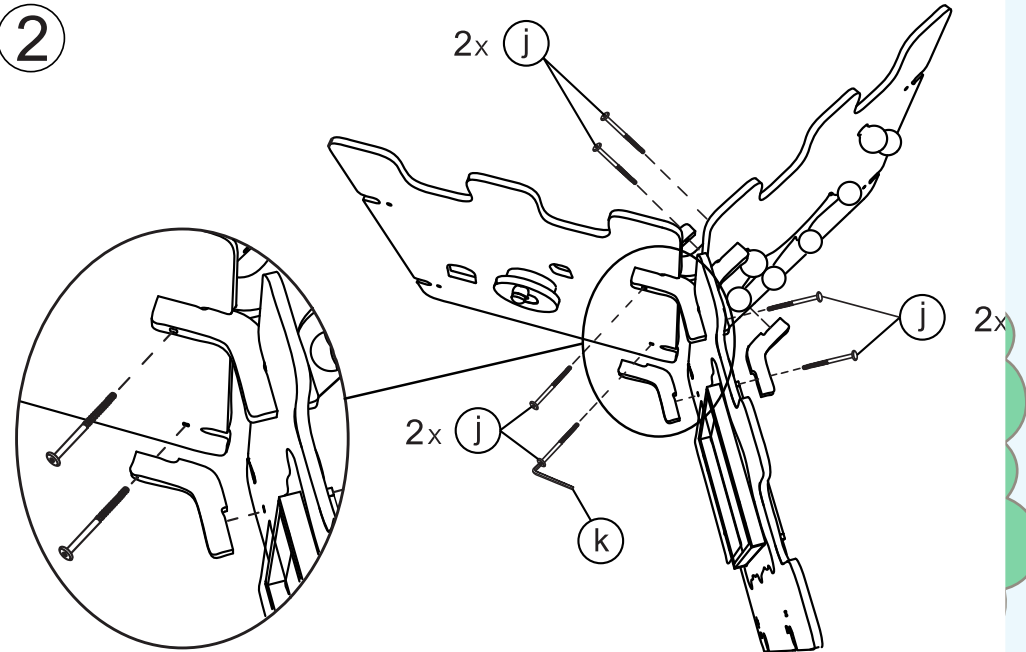

b 1x

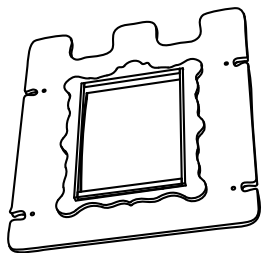

c 1x

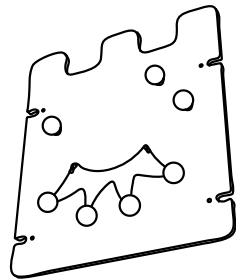

d 1x

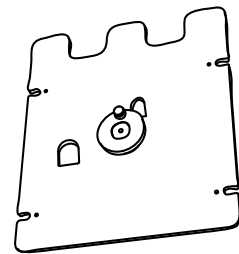

i 6x

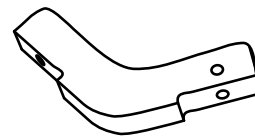

j 6x

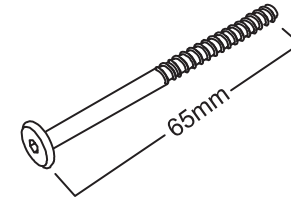

k 1x

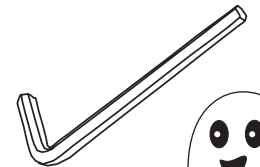

Diese Angaben und Adresse bitte aufbewahren • Please retain address • Conservez les informations, s'il vous plaît • Deze informatie goed bewaren • Roga mos garde esta información • Conservare il presente documento



beleduc

beleduc Lernspielwaren GmbH

Heinrich-Heine-Weg 2 • D-09526 Olbernhau  
Tel +49 / 3 73 60 / 162 0 • Fax +49 / 3 73 60 / 162 29  
e-mail: [info@beleduc.de](mailto:info@beleduc.de) • [www.beleduc.de](http://www.beleduc.de)

CE 2013  
Made in China ©

